

IW4518B

DUAL UP-COUNTER High-Voltage Silicon-Gate CMOS

The IW4518B Dual BCD Up-Counter consists two identical, internally synchronous 4-stage counters. The counter stages are D-type flip-flops having interchangeable CLOCK and ENABLE lines for incrementing on either the positive-going or negative-going transition. For single-unit operation the ENABLE input is maintained high and the counter advances on each positive-going transition of the CLOCK. The counters are cleared by high levels on their RESET lines.

The counter can be cascaded in the ripple mode by connecting Q4 to the enable input of the subsequent counter while the CLOCK input of the latter is held low.

- Operating Voltage Range: 3.0 to 18 V
- Maximum input current of 1 μ A at 18 V over full package-temperature range; 100 nA at 18 V and 25°C
- Noise margin (over full package temperature range):
1.0 V min @ 5.0 V supply
2.0 V min @ 10.0 V supply
2.5 V min @ 15.0 V supply

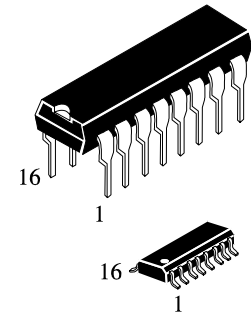

N SUFFIX
PLASTIC

D SUFFIX
SOIC

ORDERING INFORMATION

IW4518BN Plastic
IW4518BD SOIC

$T_A = -55^\circ$ to 125° C for all packages

PIN ASSIGNMENT

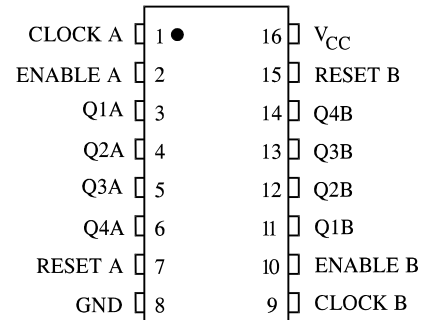

LOGIC DIAGRAM

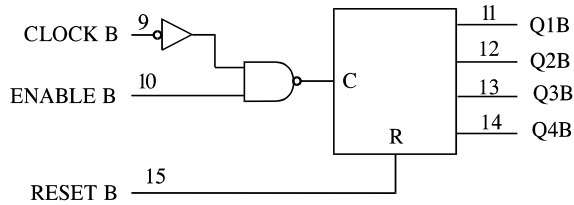
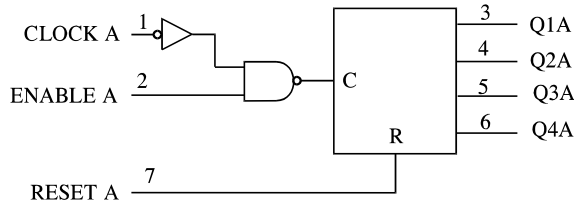

PIN 16= V_{CC}
PIN 8= GND

FUNCTION TABLE

Inputs			Outputs
CLOCK	ENABLE	RESET	Mode
	H	L	Increment Counter
L		L	Increment Counter
	X	L	No Change
X		L	No Change
	L	L	No Change
H		L	No Change
X	X	H	Q1 thru Q4=L

X = don't care

IW4518B

MAXIMUM RATINGS*

Symbol	Parameter	Value	Unit
V_{CC}	DC Supply Voltage (Referenced to GND)	-0.5 to +20	V
V_{IN}	DC Input Voltage (Referenced to GND)	-0.5 to $V_{CC} + 0.5$	V
V_{OUT}	DC Output Voltage (Referenced to GND)	-0.5 to $V_{CC} + 0.5$	V
I_{IN}	DC Input Current, per Pin	± 10	mA
P_D	Power Dissipation in Still Air, Plastic DIP+ SOIC Package+	750 500	mW
P_D	Dissipation per Output Transistor	100	mW
Tstg	Storage Temperature	-65 to +150	°C
T_L	Lead Temperature, 1 mm from Case for 10 Seconds (Plastic DIP or SOIC Package)	260	°C

Maximum Ratings are those values beyond which damage to the device may occur. Functional operation should be restricted to the Recommended Operating Conditions.

+Derating - Plastic DIP: - 10 mW/°C from 65° to 125°C

SOIC Package: : - 7 mW/°C from 65° to 125°C

RECOMMENDED OPERATING CONDITIONS

Symbol	Parameter	Min	Max	Unit
V_{CC}	DC Supply Voltage (Referenced to GND)	3.0	18	V
V_{IN}, V_{OUT}	DC Input Voltage, Output Voltage (Referenced to GND)	0	V_{CC}	V
T_A	Operating Temperature, All Package Types	-55	+125	°C

This device contains protection circuitry to guard against damage due to high static voltages or electric fields. However, precautions must be taken to avoid applications of any voltage higher than maximum rated voltages to this high-impedance circuit. For proper operation, V_{IN} and V_{OUT} should be constrained to the range $GND \leq (V_{IN} \text{ or } V_{OUT}) \leq V_{CC}$.

Unused inputs must always be tied to an appropriate logic voltage level (e.g., either GND or V_{CC}). Unused outputs must be left open.

IW4518B

DC ELECTRICAL CHARACTERISTICS (Voltages Referenced to GND)

Symbol	Parameter		Test Conditions	V _{CC} V	Guaranteed Limit			Unit
					≥-55°C	25°C	≤125°C	
V _{IH}	Minimum High-Level Input Voltage	High-Input	V _{OUT} = 0.5 V or V _{CC} - 0.5V V _{OUT} = 1.0 V or V _{CC} - 1.0 V V _{OUT} = 1.5 V or V _{CC} - 1.5V	5.0	3.5	3.5	3.5	V
				10	7	7	7	
				15	11	11	11	
V _{IL}	Maximum Low-Level Input Voltage	Low-Input	V _{OUT} = 0.5 V or V _{CC} - 0.5V V _{OUT} = 1.0 V or V _{CC} - 1.0 V V _{OUT} = 1.5 V or V _{CC} - 1.5V	5.0	1.5	1.5	1.5	V
				10	3	3	3	
				15	4	4	4	
V _{OH}	Minimum High-Level Output Voltage	High-Output	V _{IN} =GND or V _{CC}	5.0	4.95	4.95	4.95	V
				10	9.95	9.95	9.95	
				15	14.95	14.95	14.95	
V _{OL}	Maximum Low-Level Output Voltage	Low-Output	V _{IN} =GND or V _{CC}	5.0	0.05	0.05	0.05	V
				10	0.05	0.05	0.05	
				15	0.05	0.05	0.05	
I _{IN}	Maximum Input Leakage Current	Input	V _{IN} = GND or V _{CC}	18	±0.1	±0.1	±1.0	μA
I _{CC}	Maximum Quiescent Supply Current (per Package)	Supply	V _{IN} = GND or V _{CC}	5.0	5	5	150	μA
				10	10	10	300	
				15	20	20	600	
				20	100	100	3000	
I _{OL}	Minimum Low Output Current (Sink)	Output (Sink)	V _{IN} = GND or V _{CC} U _{OL} =0.4 V U _{OL} =0.5 V U _{OL} =1.5 V	5.0	0.64	0.51	0.36	mA
				10	1.6	1.3	0.9	
				15	4.2	3.4	2.4	
I _{OH}	Minimum High Output Current (Source)	Output (Source)	V _{IN} = GND or V _{CC} U _{OH} =2.5 V U _{OH} =4.6 V U _{OH} =9.5 V U _{OH} =13.5 V	5.0	-2	-1.6	-1.15	mA
				5.0	-0.64	-0.51	-0.36	
				10	-1.6	-1.3	-0.9	
				15	-4.2	-3.4	-2.4	

IW4518B

AC ELECTRICAL CHARACTERISTICS ($C_L=50\text{pF}$, $R_L=200\text{k}\Omega$, Input $t_r=t_f=20\text{ ns}$)

Symbol	Parameter	V_{CC} V	Guaranteed Limit			Unit
			≥ -55 $^{\circ}\text{C}$	25°C	≤ 125 $^{\circ}\text{C}$	
f_{max}	Maximum Clock Frequency, (Figure 1)	5.0	1.5	1.5	0.75	MHz
		10	3	3	1.5	
		15	4	4	2	
t_{PHL} , t_{PLH}	Maximum Propagation Delay, Clock or Enable to Output (Figures 1,3)	5.0	560	560	1120	ns
		10	230	230	460	
		15	160	160	320	
t_{PHL}	Maximum Propagation Delay, Reset to Output (Figure 2)	5.0	650	650	1300	ns
		10	225	225	450	
		15	170	170	340	
t_{THL} , t_{TLH}	Maximum Output Transition Time, Any Output (Figure 1)	5.0	200	200	400	ns
		10	100	100	200	
		15	80	80	160	
C_{IN}	Maximum Input Capacitance	-		7.5		pF

TIMING REQUIREMENTS ($C_L=50\text{pF}$, $R_L=200\text{ k}\Omega$, Input $t_r=t_f=20\text{ ns}$)

Symbol	Parameter	V_{CC} V	Guaranteed Limit			Unit
			≥ -55 $^{\circ}\text{C}$	25°C	≤ 125 $^{\circ}\text{C}$	
t_w	Minimum Pulse Width, Clock (Figure 1)	5.0	200	200	400	ns
		10	100	100	200	
		15	70	70	140	
t_w	Minimum Pulse Width, Reset (Figure 2)	5.0	250	250	500	ns
		10	110	110	220	
		15	80	80	160	
t_w	Minimum Pulse Width, Enable (Figure 3)	5.0	400	400	800	ns
		10	200	200	400	
		15	140	140	280	
t_r , t_f	Maximum Input Rise and Fall Times (Figure 1)	5.0	15	15	15	μs
		10	5	5	5	
		15	5	5	5	

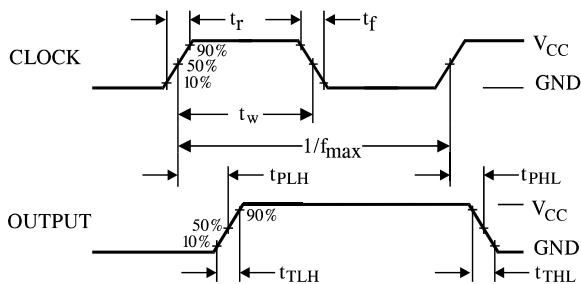

Figure 1. Switching Waveforms

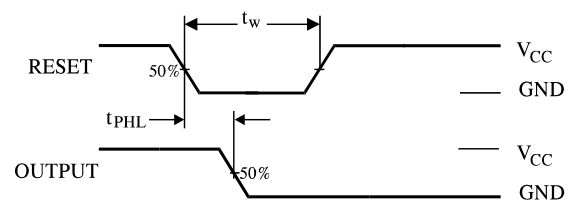

Figure 2. Switching Waveforms

IW4518B

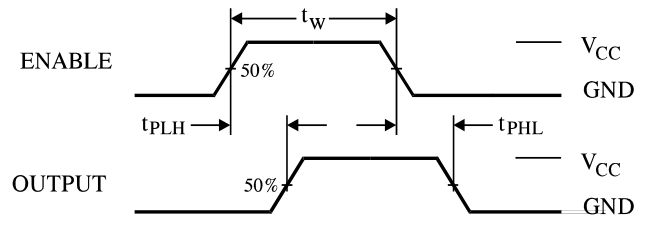
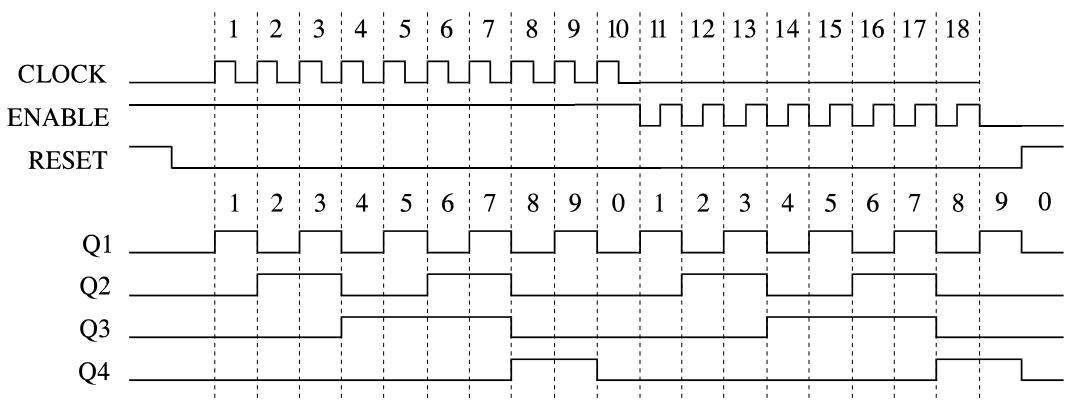

Figure 3. Switching Waveforms

TIMING DIAGRAM



EXPANDED LOGIC DIAGRAM (1/2 of the Device)

